



ICANN | 53   
*Buenos Aires*

21-25 JUNE 2015

**CCWG-Accountability Update**



# Part of a Process

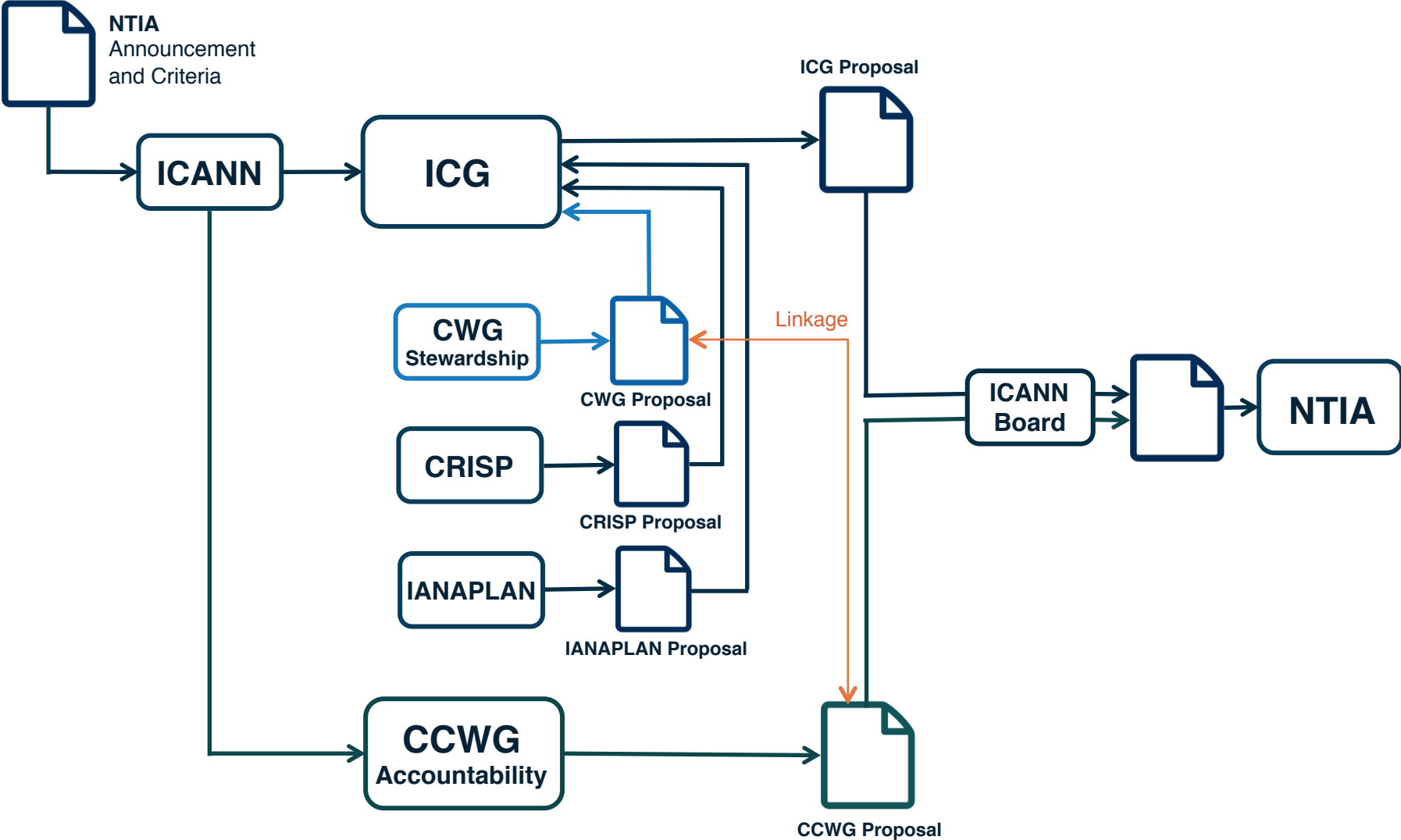

# Goals and Requirements

## Goal:

Deliver proposals that would enhance ICANN's accountability towards all stakeholders.

## The CCWG-Accountability has two Work Streams:



### Work Stream 1

Focused on mechanisms enhancing ICANN-Accountability that must be in place or committed to within the time frame of the IANA Stewardship Transition



### Work Stream 2

Focused on addressing accountability topics for which a timeline for developing solutions and full implementation may extend beyond the IANA Stewardship Transition

# Statistics and Diversity of the CCWG

 **26** Members  
 **120** Participants

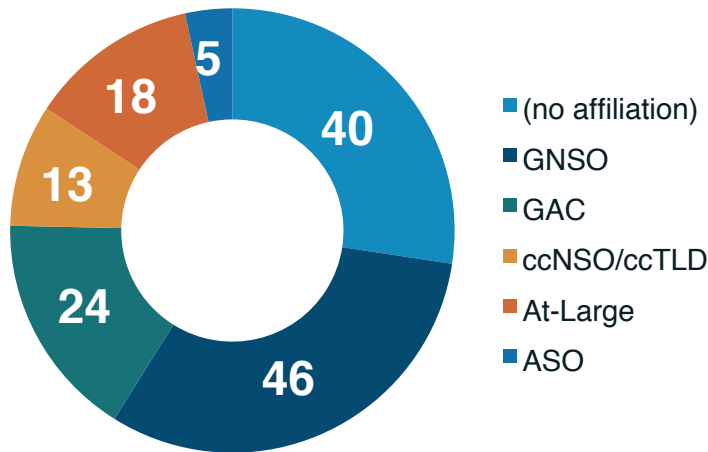

**94**  
Calls/Meetings



**5,504**  
Volunteer Hours



**5,043**  
Mailing List Messages

# Building Blocks



## Empowered Community

Refers to the powers that allow the community i.e. the people to take action should ICANN breach the principles



## ICANN Board

Represents the executive entity selected/elected by the community to be in charge of managing and directing the affairs of the corporation



## Principles Form the Mission

Guarantees and core values of the organization i.e the Constitution



## Independent Review Mechanisms

i.e. the judiciary, confers the power to review and provide redress, as needed

# Pre-Transition

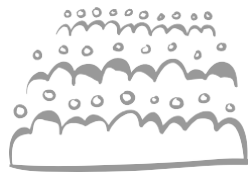

**Community**

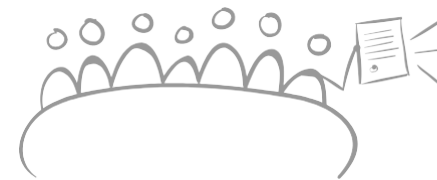

**BUDGET  
STRAT/OPS  
BYLAWS**

**Board**

**Principles**



**Independent  
Appeals  
Mechanism**



**IRP**



# Post-Transition: Empowered Community

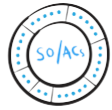

**Empowered  
Community**

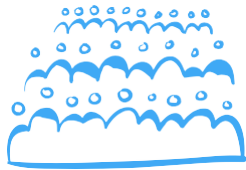

**Community**

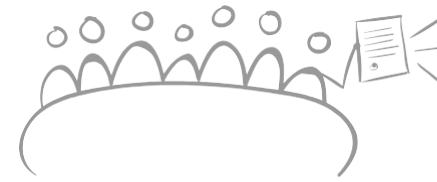

**BUDGET  
STRAT/OPS  
BYLAWS**

**Board**

**Principles**

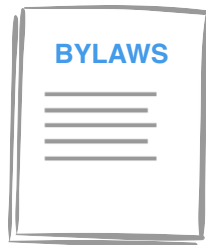

**Independent  
Appeals  
Mechanism**



**IRP**

# Post-Transition: Community Powers

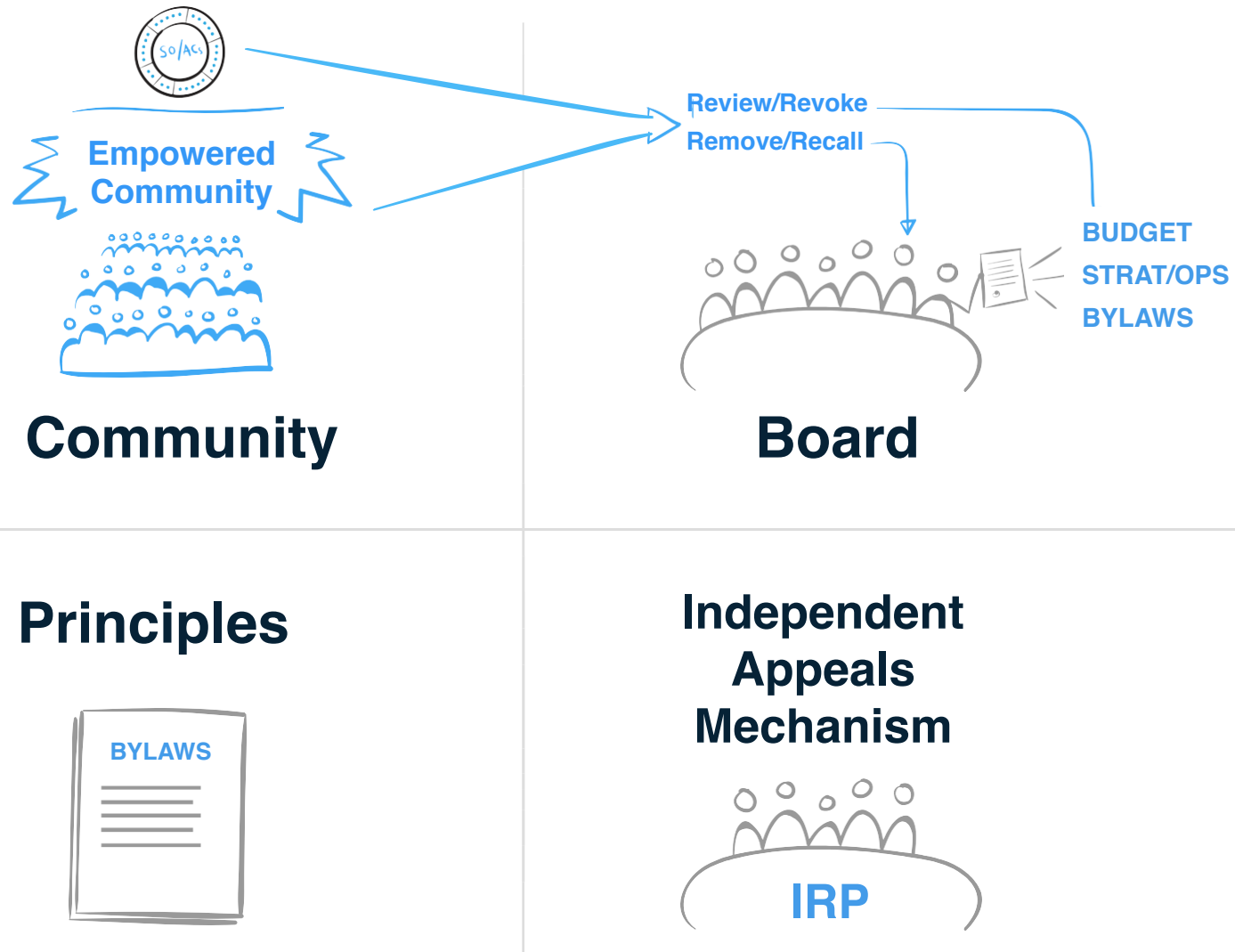



# Post-Transition: Extra Bylaws & Fundamental Bylaws

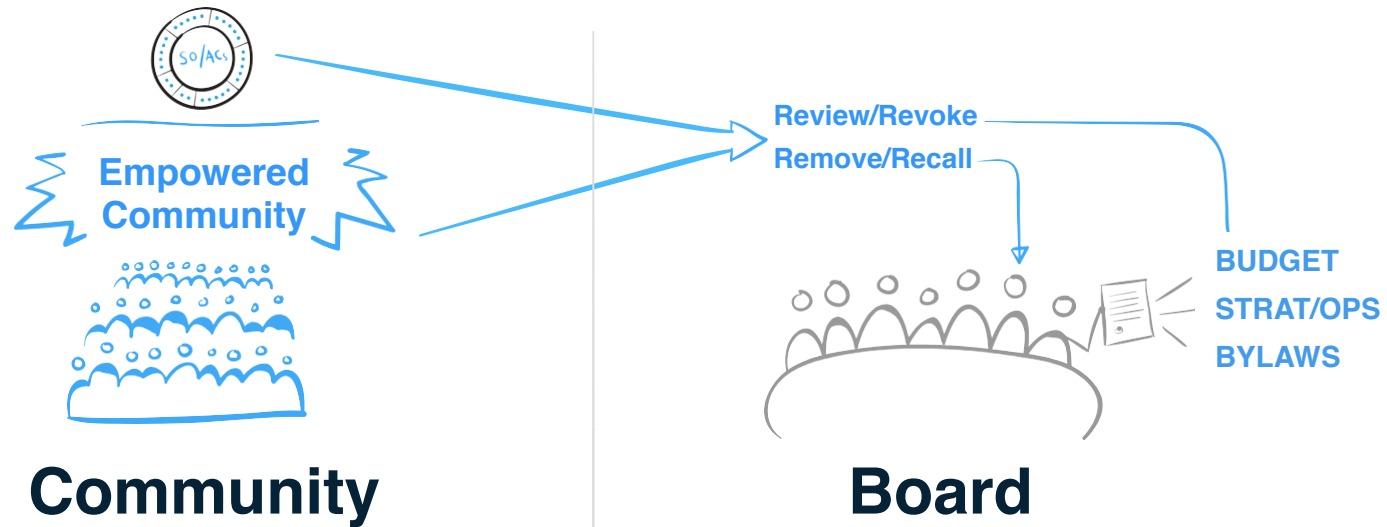

## Principles

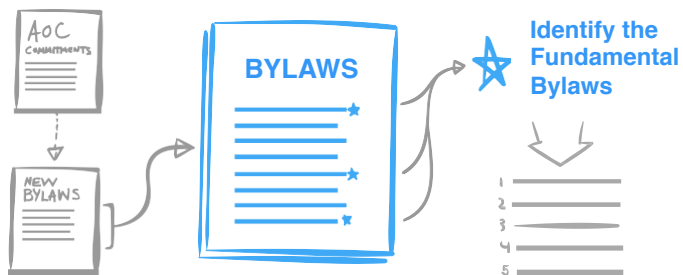

## Independent Appeals Mechanism



# Post-Transition: Enhanced IRP

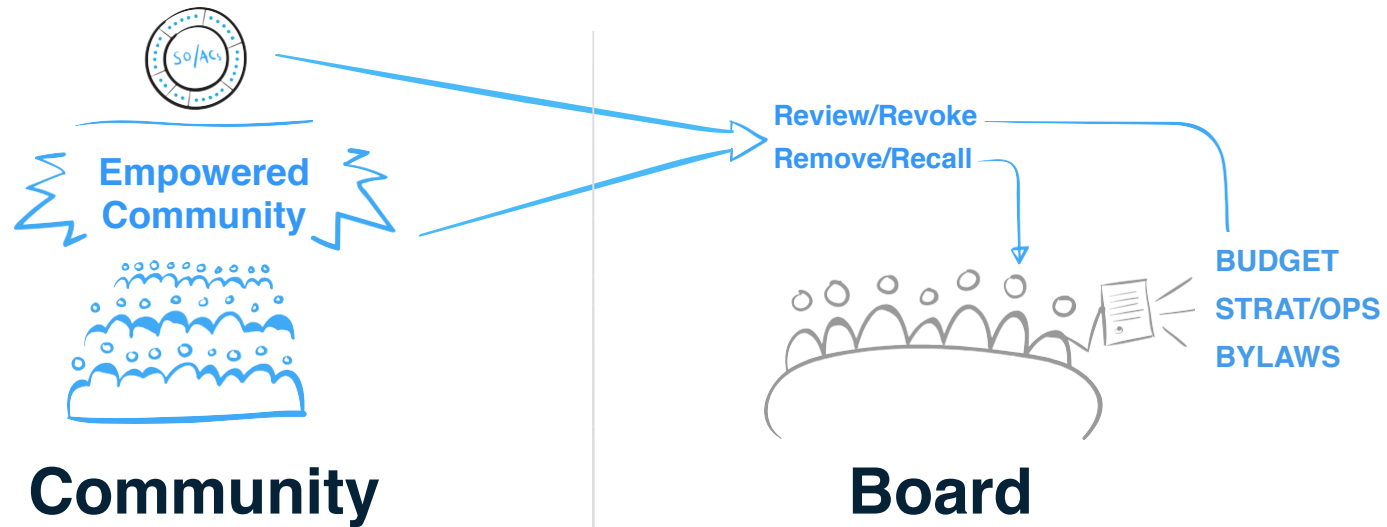

## Principles

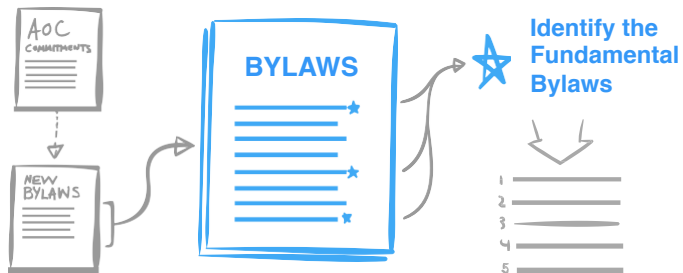

## Independent Appeals Mechanism

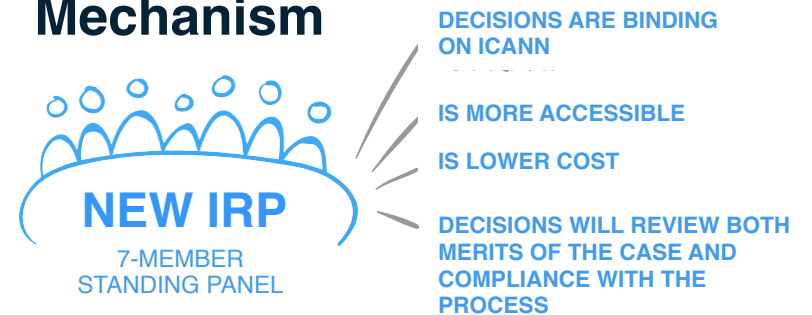

# SO/AC Membership Model

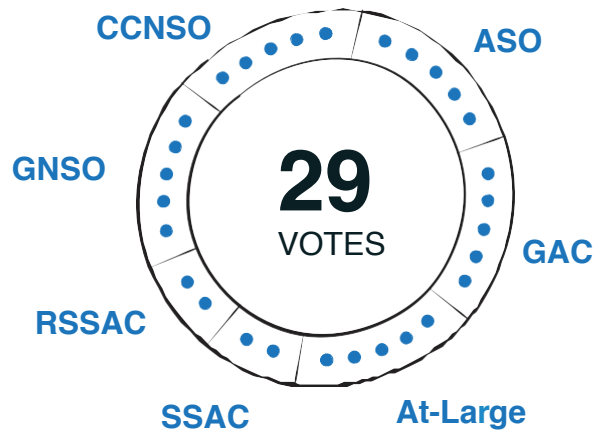
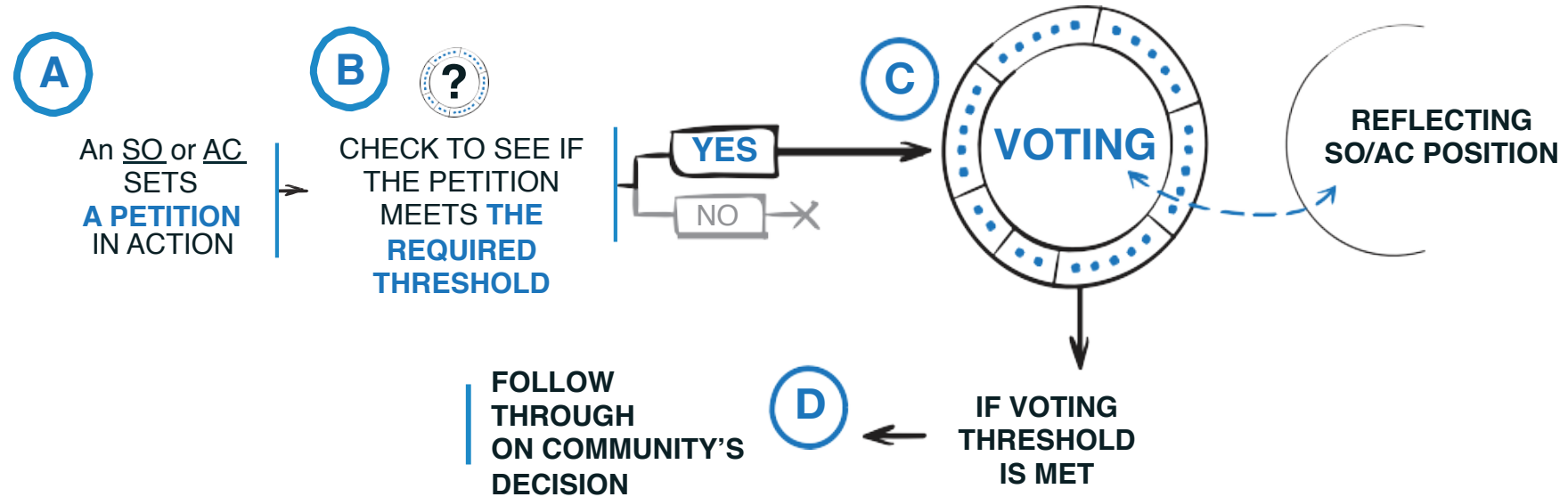

## Influence in the Community Mechanism

Each SO and AC has a number of "votes" in the community mechanism, deciding on the powers established for the community

# Public Comment Review



## Recommendations that received strong support, near consensus

- Overall architecture (4 building blocks)
- Principle of Fundamental Bylaws
- A clearer definition of ICANN's Purpose and Mission
- Incorporation of AoC Reviews into the Bylaws



## Recommendations that require further explanation, clarification

- Independent Review Process (IRP)



## New Issues and Concerns

- Staff and management accountability (corporate culture of accountability)
- Community accountability
- Diversity
- Membership model and legal enforceability

# Linkage & Coordination with CWG-Stewardship

1

## ICANN Budget

Community rights regarding development and consideration

4

## CSC

Incorporated into the bylaws

2

## ICANN Board

Community rights, specifically to appoint/remove members, recall entire Board

5

## Independent Review Panel

Should be made applicable to IANA Functions and accessible by TLD managers

3

## IANA Function Review

Incorporated into the bylaws

6

## Fundamental bylaws

All foregoing mechanisms are to be provided for in the bylaws as “fundamental bylaws”

**The CWG-Stewardship’s proposal is expressly conditioned upon the outcomes of the CCWG-Accountability.**